

Shepherd 210A Fingerprint Door Lock Installation Manual V1.1



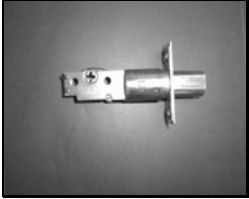

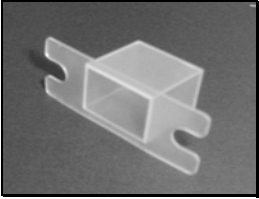

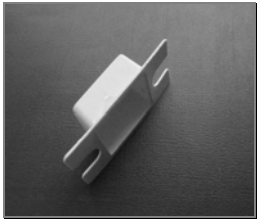
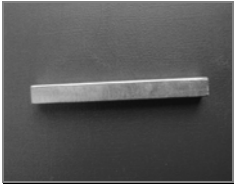

Table of Contents

1. Product and Accessories	2
1.1 Parts List.....	2
1.2 Parts Identification.....	3
2. Installation	5
2.1 Preparation before Installation.....	5
2.2 Drill Holes.....	6
2.3 Adjust Latch’s Backset.....	6
2.4 Adjust Deadbolt’s Backset.....	7
3 Install Latch, Deadbolt and Strikes	9
3.1 Install Latch and Deadbolt	9
3.2 Install Strikes and Lining Boxes.....	10
4 Install the Lock Units	11
4.1 Adjust Torque Bar Length.....	11
4.2 Remove Plate and Screws from Inside Section	11
4.3 Mounting of Outside Section onto door.....	12
4.4 Mounting the Plat to Fix Outside Section onto Door	13
4.5 Install Inside Section of Lock	14
4.6 Check and Adjust after Installation	15
5 Problems or Feedback	16

1. Product and Accessories

1.1 Parts List

After opening the package, please check the product and accessories. If any are missing or damaged, please contact your dealer for replacement.

		
Inside unit	Outside unit	Pinch screws
		
Deadbolt	Deadbolt strike	Deadbolt strike lining box
		
Latch	Latch strike	Latch strike lining box
		
Square axis for latch	Wood screw	Emergency keys

1.2 Parts Identification

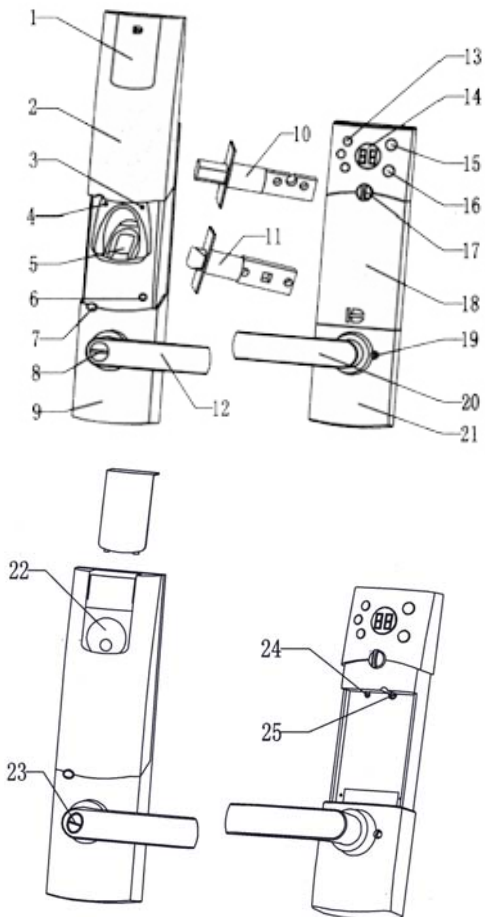

1. Decoration plate	14. LED display
2. Sliding dust cover	15. Inside unlocking button
3. Green LED indicator	16. Inside locking button

4. Red LED indicator	17. Battery compartment knob
5. Fingerprint scanning window	18. Battery compartment
6. Power on switch	19. Pinch screw holes
7. Outside locking button	20. Inside lever
8. Emergency keyhole cover	21. Inside unit body
9. Outside unit body	22. Deadbolt keyhole
10. Deadbolt	23. Latch emergency keyhole
11. Latch	24. Deadbolt emergency release hole
12. Outside lever	25. Pinch screw hole
13. Function keys	

2. Installation

2.1 Preparation before Installation

Your lock must correspond to your door being left-handed or right-handed. If not, you should ask your seller to exchange it. (Refer to Figure1)

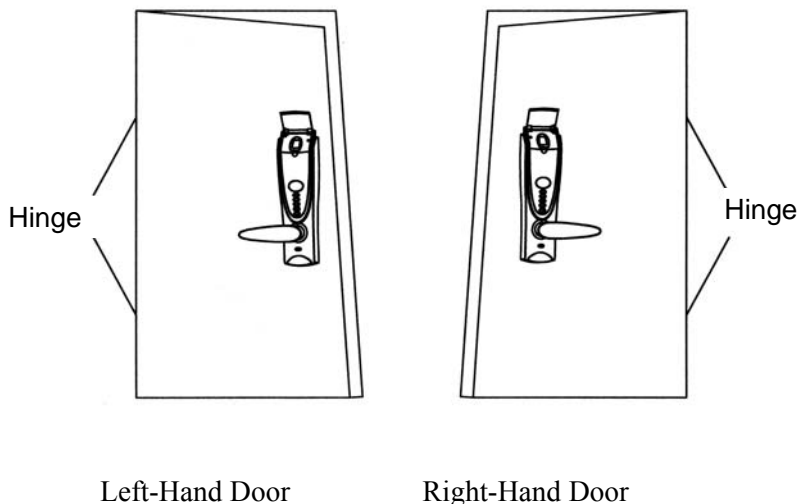

Fig 1: Viewing from the outside; definition of doors

☀ Tip: How to determine the door opening direction?

Standing outdoor and face the door: If the hinge is at the left side of the door, the door is a left-handed door - the left-handed lock should be used. If the hinge is at the right side of the door, the door is a right-handed door - the right-handed lock should be used.

The lock lever is designed to be interchangeable with the popular Schlage or Kwikset standard for 2 lock hole doors. If your door has only one hole or no holes in the door, follow the instructions below. (Note: Most hardware stores have 2-1/8" and 1" hole cutters that fit standard hand drills.)

2.2 Drill Holes

(1) Paste the provided cutout template on the door as shown in the figure. Mark 1" holes at center of door edge and make 2" holes at the surface of the door (the offset is 2 3/8" or 2 3/4" from door edge to the center of the 2" hole).

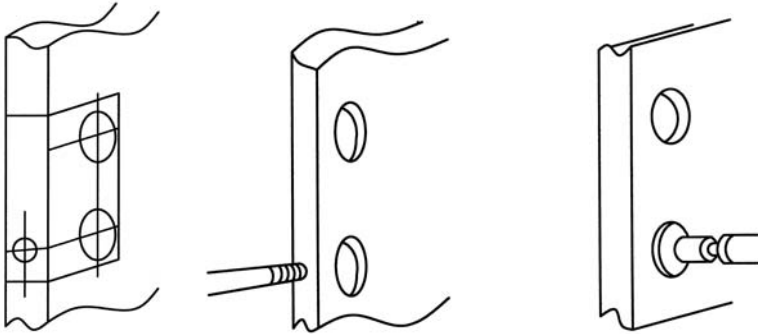

(2) Drill two 1" holes on door edge. And drill two 2" holes on the door surface.

Hint: To avoid cracking the door surface, the 2" holes should be drilled from both sides.

(3) There are adjustable backsets for the latch and deadbolt. Set them to either 2 3/8" or 2 3/4" as appropriate for your door.

2.3 Adjust Latch's Backset

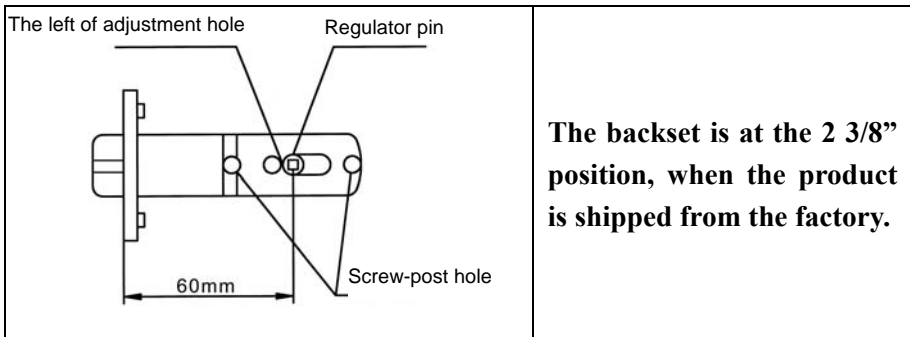

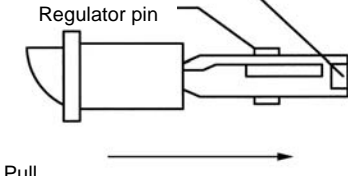
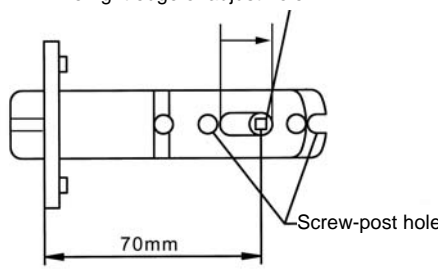
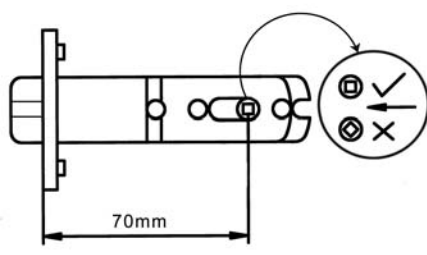
<p>The clip of regulator pin</p> <p>Regulator pin</p>  <p>Pull</p>	<p>Pull regulator pin to the right edge.</p>
<p>The right edge of adjust hole</p>  <p>70mm</p> <p>Screw-post hole</p>	<p>The backset has been adjusted to 2 3/4" position.</p>
 <p>70mm</p>	<p>Make sure the regulator pin is at the correct angle as shown.</p>

2.4 Adjust the Deadbolt's Backset

<p>Deadbolt Head</p> <p>Pinch Screw Holes</p> <p>Driving Board Hole</p>	<p>The backset is at the 2 3/8" (60 mm) position, when the product is shipped from the factory.</p> <p>Insert a flat screwdriver into driving board hole, turn driving board to let the deadbolt head draws in.</p>
<p>Turn</p> <p>Pull</p>	<p>Pull regulator pin up, firmly hold driving board and driving spring and pull right until the 2 3/4" screw hole coincides with driving board hole.</p>
	<p>Figure shows the backset is in 2 3/4" (70 mm) position.</p>

3 Install Latch, Deadbolt and Strikes

3.1 Install Latch and Deadbolt

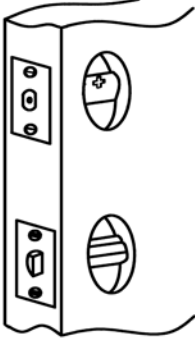
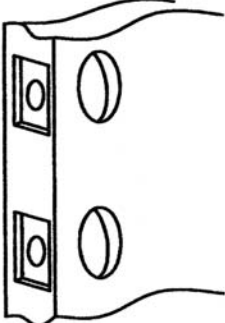
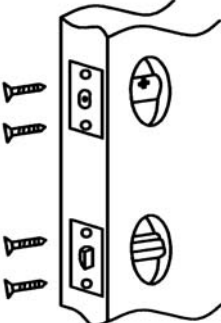
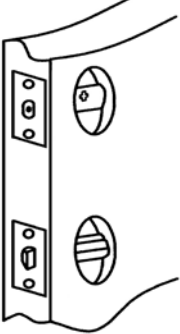
	
<p>Insert the lock bolt into the hole, mark the frame lines of foil board. The frame lines should be parallel with the door edge.</p>	<p>Dig a support notch 1/8" in depth. The notch edge lines should be parallel with the door edge.</p>
	
<p>Insert latch and deadbolt, and tighten the screws (the slanted plane of latch should face the door closing direction, and the UP mark of the deadbolt should point up).</p>	<p>After the screws are tightened, the foil board should be exactly in the door center and parallel with door edge.</p>

3.2 Install Strikes and Lining Boxes

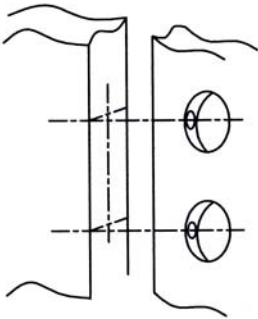
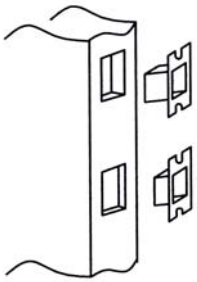
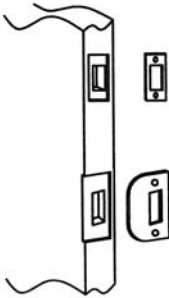
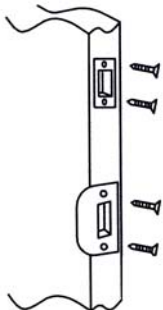
	
<p>Close the door; use pencil to mark strike hole in the doorjamb from face hole.</p>	<p>Cut out a square cavity to accept the strike box at the marked location in the doorjamb.</p>
	
<p>Draw strike plate line and screw holes Cut 1/16" notches for the strike plates.</p>	<p>Install strikes, tighten the screws.</p>

4 Install the Lock Units

(Note: The **DL210A** fits standard door thicknesses of 1 1/2" to 2 1/8". It is possible to fit doors down to 1" and up to 2 1/4" in thickness door by ordering special length of torque bars and square axes from manufactory.

4.1 Adjust Torque Bar Length

The length of torque bar is longer than normal when shipped from the factory. You need to cut off the length of torque bar equal to thickness of the door. You can put the outside section on the table, and let deadbolt toward up, measure the length of deadbolt (from the base of outside section) and make a mark at thickness of the door, than cut it.

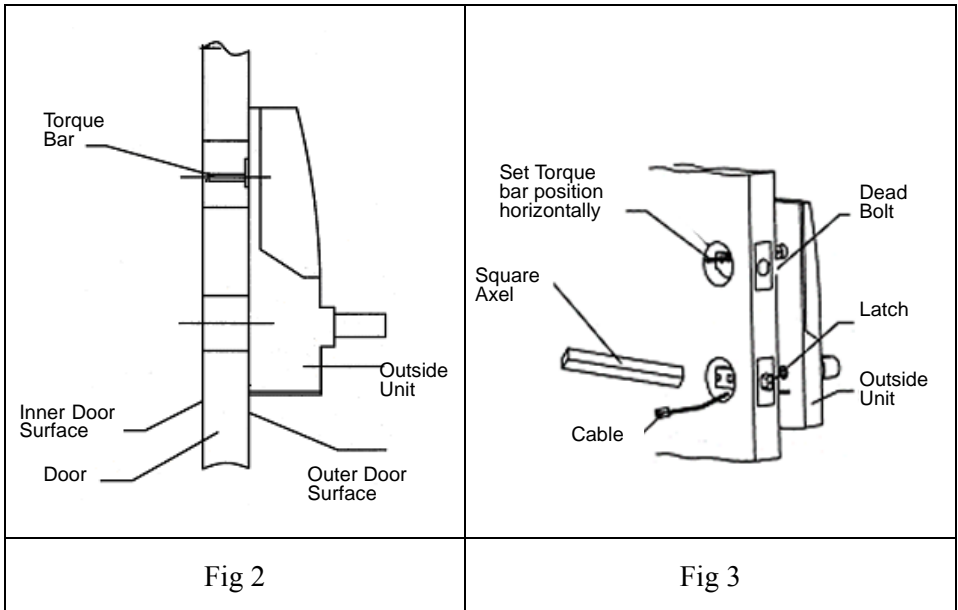

4.2 Remove Plate and Screws from Inside Section

Remove the battery cover on Inside Section of lock. And remove **Plate** from

Inside Section by unscrewing the two **A** screws on the side of the lock. Save removed parts for later use. (Fig 4, 5)

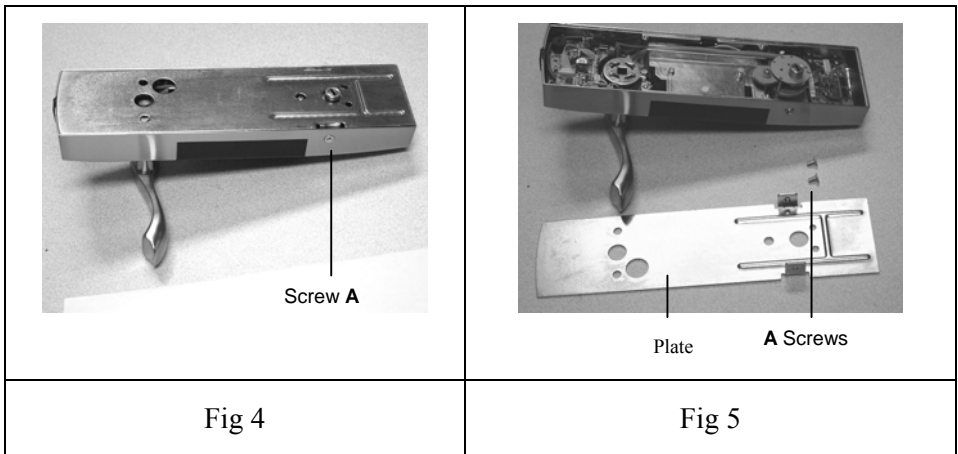

4.3 Mounting of Outside Section onto door

1. Put rubber gasket on the Outside Section of lock, with the smooth side away from lock. (Ignore shape of cutout holes; it doesn't matter.) (Fig 6, 7)

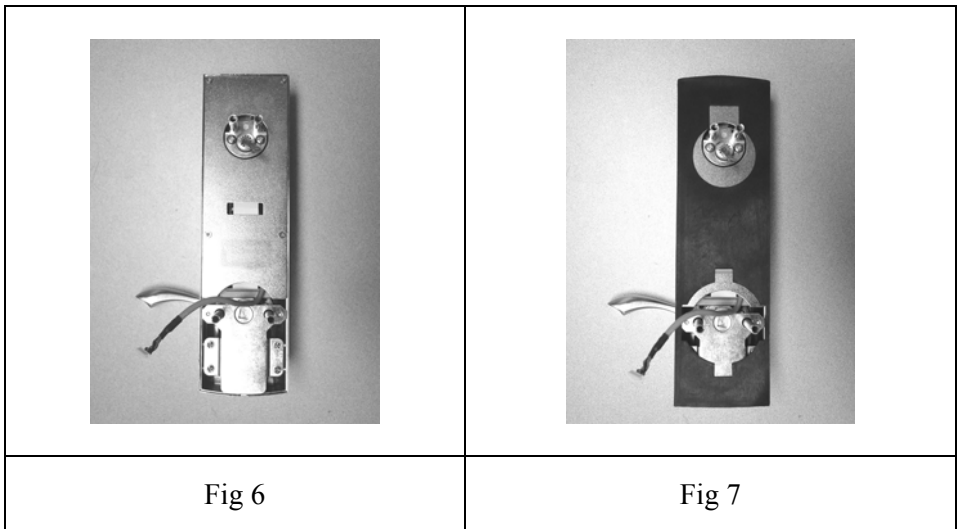

2. Be sure you start from the outside of the door with the Outside Section of the lock and feed cable to the inside through the second hole from the bottom.
3. EXTEND the deadbolt. Start feeding the two bolts near the bottom of the lock through the two respective holes in the door. When started, start jiggling the lock into the door while positioning the loose torque bar at the deadbolt end of the lock so it slips **HORIZONTALLY** into the deadbolt gear screw.
4. Work the unit until it is flush against the door with the rubber gasket aligned perfectly around the lock, then hold in place so it doesn't slip out.



Fig 8



Fig 9

4.4 Mounting the Plat to Fix Outside Section onto Door

Position the Plate taken off earlier from the Inside Section (Fig. 5) on the inside of the door with the two tabs at the top and sticking out. Use two **B** screws (slightly shorter of the four long pinch screws supplied) for mounting through the two holes near the top of the lock. Screw in tightly making sure rubber gasket is positioned evenly around lock.

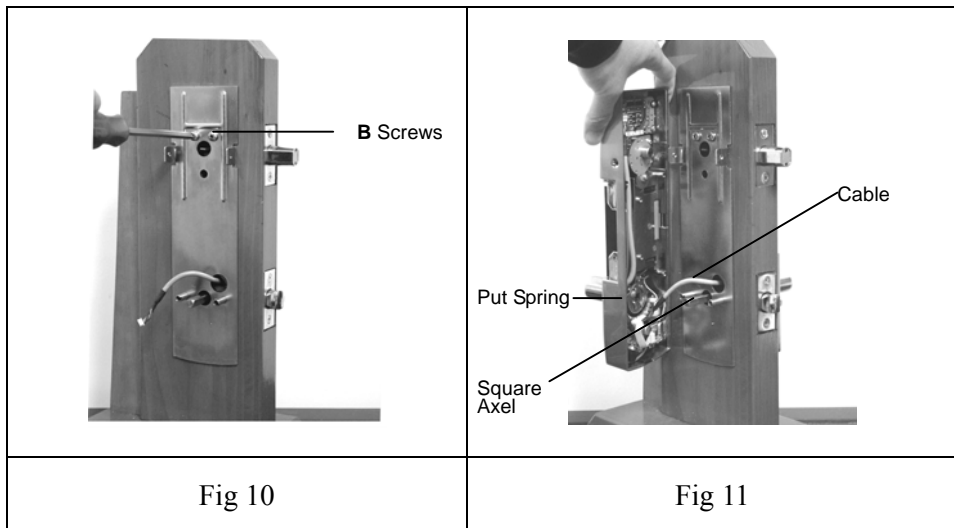

4.5 Install Inside Section of Lock

1. Plug in the **Cable** (Fig. 11) to the one connector available on the circuit board.
2. Put the little **Spring** into the square axel hole on the inside of the Outside Section, then insert the square axel into the hole, pushing against the spring.
3. Turn deadbolt finger knob until the slot lings up with the torque bar and push into place.
4. Work the Inside Section into place. Make sure the cable doesn't block the way for **C Screws**.
5. Fasten Inside Section in place by replacing the two small **A Screws** on the side of the unit. (Fig. 12)
6. Fasten the two long **C Screws** on the lower portion of the unit. (Fig. 13)

Note: Don't fasten screws too tight before final checkup.

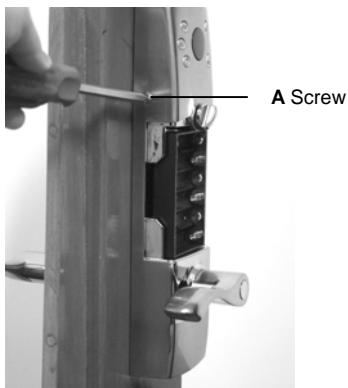

Fig 12

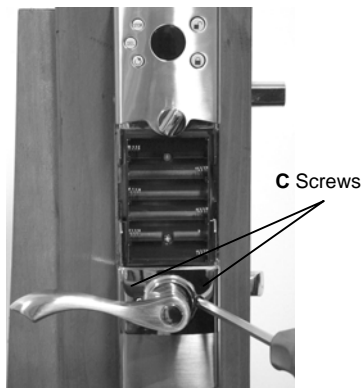

Fig 13

4.6 Check and Adjust after Installation

Check the mechanical assembly as follows:

1. Leave door open, install six (6) AA batteries.
2. Turn inside lever, latch should move freely in and out. Turn outside lever, latch should not move.
3. Press Inside LOCK button, deadbolt should pop out; press Inside UNLOCK button, deadbolt should retract.
4. Press Outside LOCK button, deadbolt should pop out.
5. If everything works fine, fasten four screws (screws A and C) tightly to finish the installation.

Congratulations! You are done with the installation!

☀ **Tip:** If the deadbolt does not moves smoothly, loosen pinch screws a little and adjust the lock body position until the deadbolt moves smoothly.